

scraplights® classic series

Installation instructions Instructions d'installation

Max 15W LED, 2700K, E26, 120V

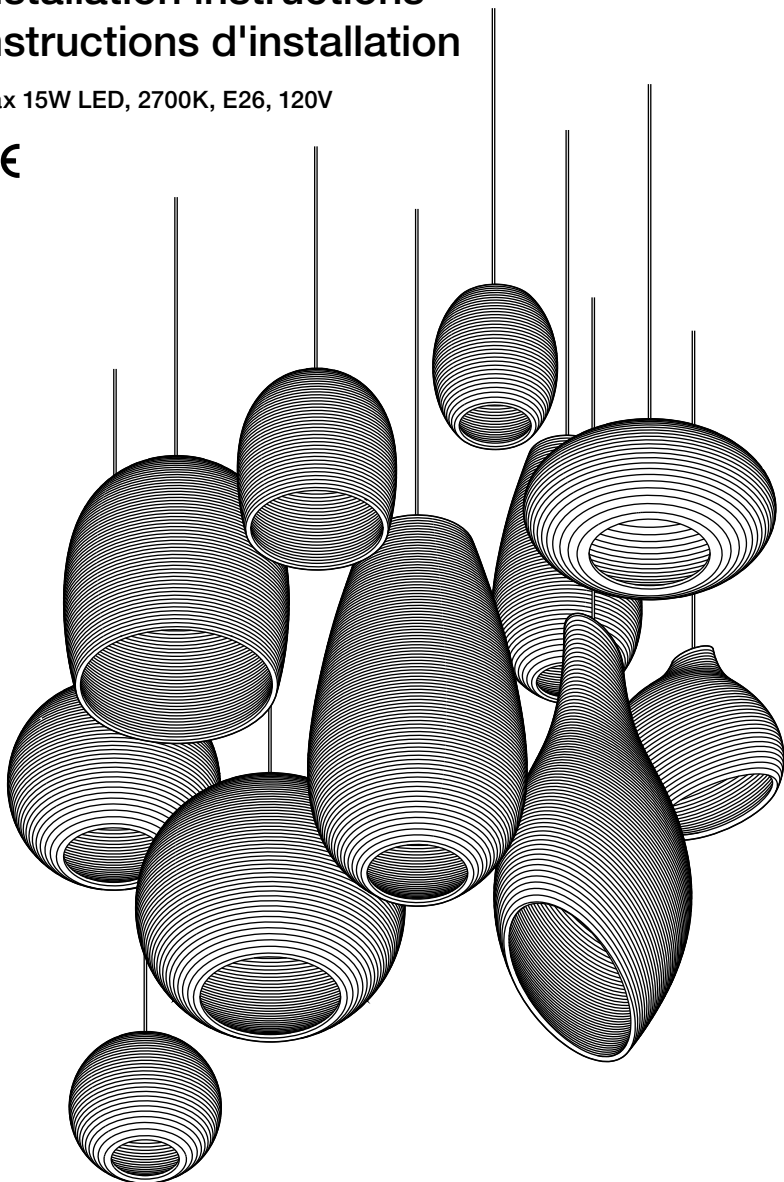

NA V11

 graypants®



Warnings

- Consult a licensed electrician before wiring to the ceiling.
- Install in a location that has plenty of room around the light.
- Keep away from direct sunlight.
- Maintain at least 12in (31cm) between the lamp and canopy.

Before installing

Disconnect power: Use voltmeter to verify that there is no voltage present on the switch wire.

Tip: Hang a card in the fuse box so no one accidentally turns on the power.

Check with a cable locator if there are no electrical lines running through the spot where you want to drill. Otherwise there can be a risk of short circuits.

Avertissement

- Consulter un électricien agréé avant de câbler au plafond.
- Installer dans un endroit qui a beaucoup d'espace autour de la lumière.
- Tenir à l'écart de la lumière directe du soleil.
- Maintenir au moins 31 cm entre la lampe et la canopée.

Avant l'installation

Déconnecter l'alimentation: Vérifier à l'aide d'un testeur que le courant est bien coupé en sortie des fils d'alimentation.

Astuce: Accrocher une carte dans la boîte à disjoncteur divisionnaire afin que personne n'allume accidentellement le courant.

Vérifier avec un localisateur de câble s'il n'y a pas de fils électriques qui traversent l'endroit où vous voulez percer. Sinon, il peut y avoir un risque de court-circuit.

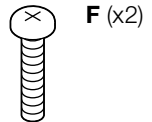
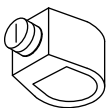
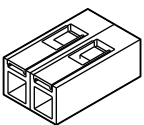
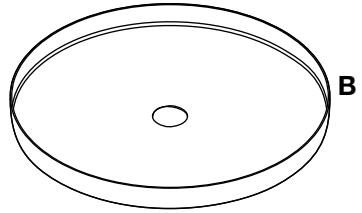
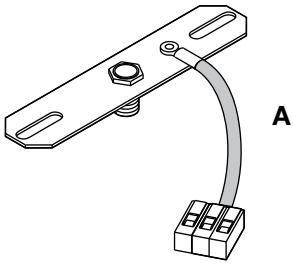
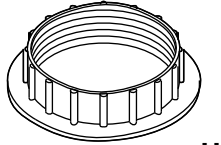
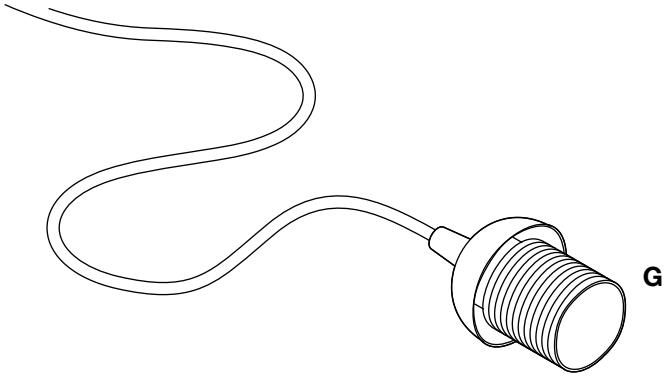

1

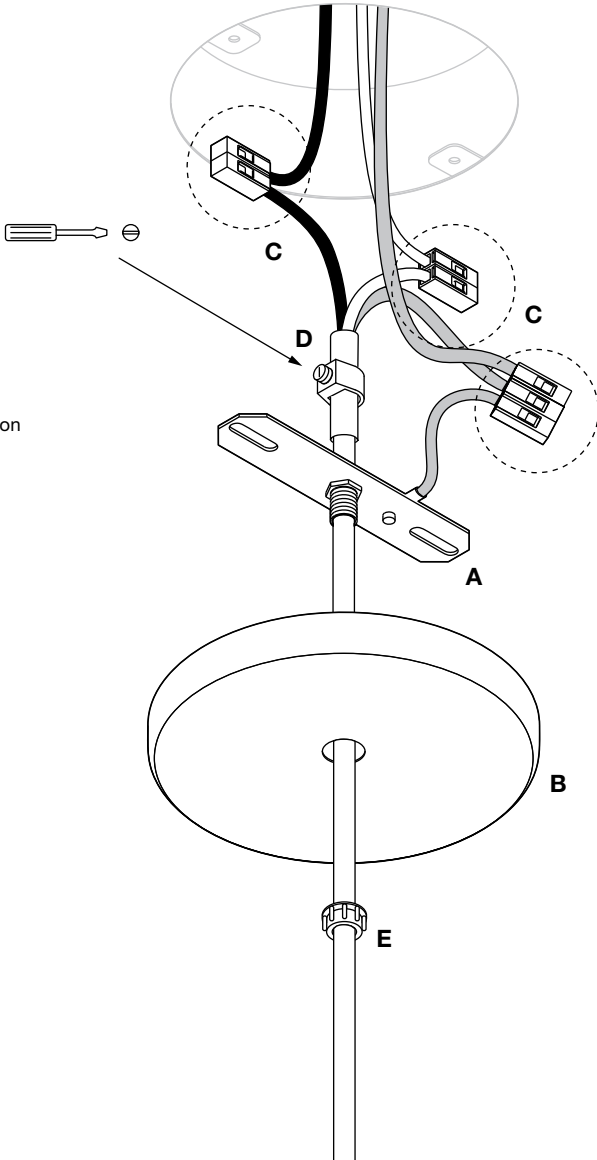
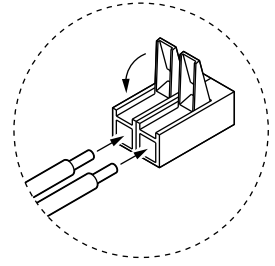

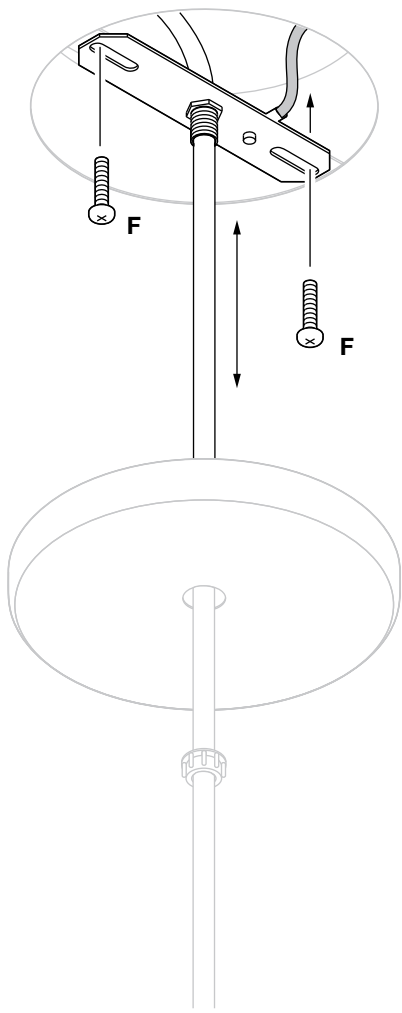

3

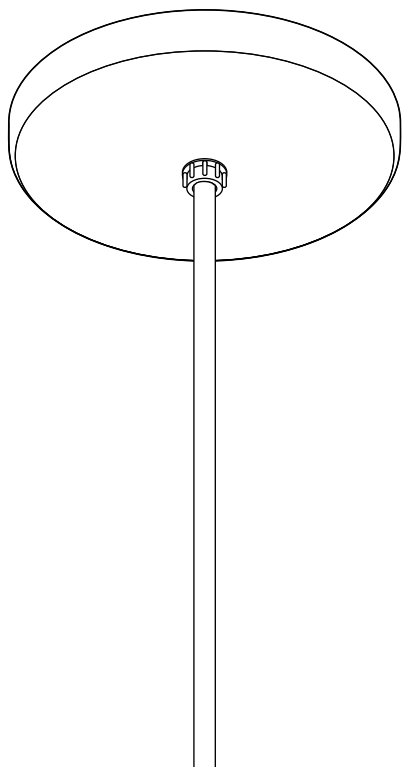

4

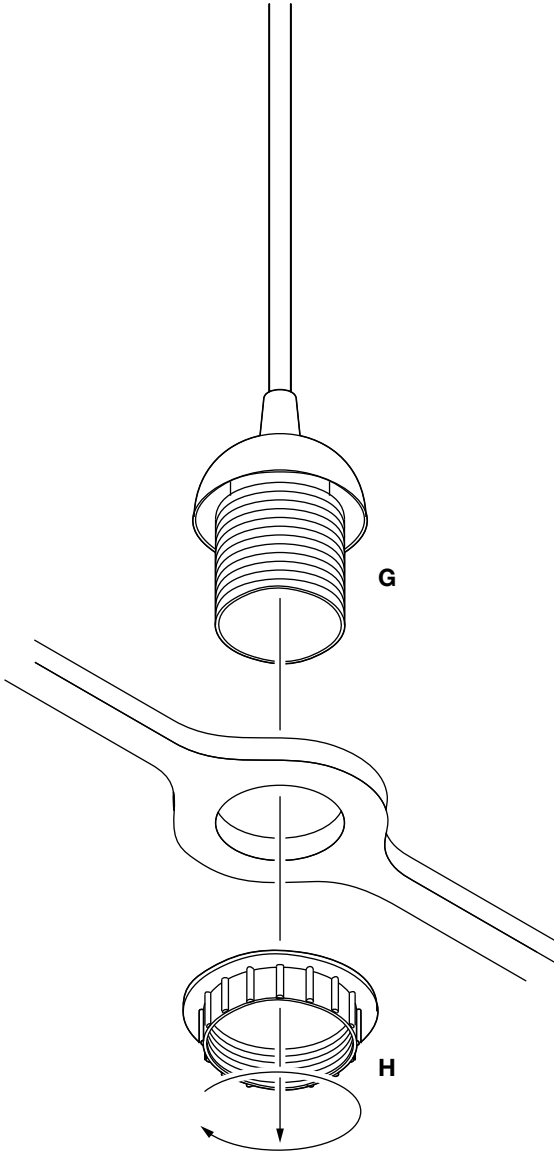

Seattle

3220 1st. Ave. S. Suite 400
Seattle, WA 98134
(206) 420-3912
seattle@graypants.com

Amsterdam

Meeuwenlaan 126B
1021 JN Amsterdam
+31 (0) 20 820 8990
amsterdam@graypants.com